

# 5 CLAMPS, FASTENERS AND ANCHORS

# STRUTFAST

## Cable and Pipe Clamps

### K/U PIPE/CABLE CLAMPS

'K/U' CABLE CLAMP	UNIT PRICE	CABLE OR PIPE DIA mm	PRESSURE SHOE PRICE
K/U2026	21.96	14	2.53
K/U2027	22.25	16	2.53
K/U2028	22.79	20	2.82
K/U2030	23.56	26	2.82
K/U2032	24.45	32	3.27
K/U2034	25.43	40	4.48
K/U2036	28.78	46	4.79
K/U2038	30.38	52	5.05
K/U2040	31.27	58	5.21
K/U2042	32.64	66	5.47
K/U2043	33.62	70	5.90
K/U2044	34.77	78	6.15

FINISH: HOT DIP GALVANIZED  
FASTENERS: YELLOW PASSIVATED

'K/U' CLAMP



'K/U' CLAMP



'K/U' CLAMP

### TWO PIECE PIPE/CABLE CLAMPS

PRODUCT RANGE	CABLE OR PIPE DIA mm	SCREW SIZE	PRICE INCL. SCREW & NUT
F2025	7.5-14	M6	14.95
F1108	7-13		14.95
F2026	11.5-13.5	X	14.95
F1108A	10.5-15		14.95
F2027	13-17	20mm	14.95
F1109	15-18		15.25
F2028	16.5-19.5	(HEX SET SCREW & NUT)	15.25
F1111	19-23		15.58
F2030	21-30	M6	17.37
F1112	24-29		17.40
F2032	27-35	X	18.18
F1113	32-36		19.79
F2034	32-39	25mm	19.79
F1114	38-44		20.47
F1115	43-57	(HEX SET SCREW & NUT)	20.64
F2038	47-57		24.44
F2039	47-61	M8	24.74
F1117	54-70		28.70
F2043	62-75	X	25.89
F1118	71-85		95.55
F1119	87-95	(HEX SET SCREW & NUT)	96.90
F1120	99-110		39.35
F1121	110-122	M10	44.76
F1122	116-140		52.18
F1123	135-145	X	54.93
F1124	155-180		65.01
F1125	175-206	(HEX SET SCREW & NUT)	70.51
F1126	188-228		76.90
F1127	235-270	M10	88.94
F1129	260-285		99.87

FINISH: CLAMP: PRE-GALVANIZED  
FASTENERS: ELECTRO-GALVANIZED



# 5 CLAMPS, FASTENERS AND ANCHORS



## Cable and Pipe Clamps

### F2239 - SERIES PIPE CLAMPS

PRODUCT RANGE	BOLT AND NUT SET	PRICE INCL. BOLT & NUT	PIPE DIAM. (mm)
F2239/20	M12 X 45mm	56.67	1 60
F2239/25		61.48	2 76
F2239/30		66.10	3 89
F2239/40	M12 X 60mm	77.92	4 114
F2239/60		96.39	5 166
F2239/80		222.64	6 219
F2239/100	M20 X 70mm	253.00	7 273
F2239/120		285.70	8 324



FINISH: HOT-DIP GALVANIZED



HANGER

F2400

24.75

### SS - SERIES PIPE CLAMPS

PRODUCT RANGE	UNIT PRICE	PIPE DIAM. (mm)
SS1	8.48	21
SS1/1	9.17	27
SS1/2	10.05	34
SS1/3	11.39	42
SS1/4	33.40	48
SS1/5	16.19	60
SS1/6	19.42	76
SS1/7	35.61	89
SS1/8	37.32	101
SS1/9	39.09	114
SS1/10	42.00	142
SS1/11	50.79	173
SS1/12	57.82	219

FINISH: PRE-GALVANIZED



### TREFOIL CLAMPS - ALUMINIUM

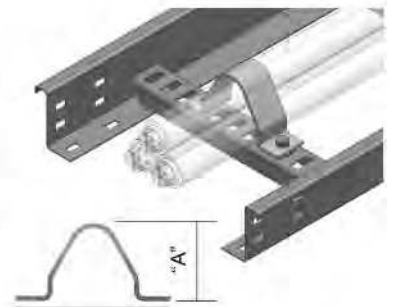

FINISH :  
CLAMP : ALUMINIUM  
FASTENER : CADMIUM PLATED  
BASE PLATE : PRE-GALVANISED

### F75 - SERIES PIPE CLAMPS

PRODUCT RANGE	UNIT PRICE	PIPE DIA (mm)	HOLE SIZE
F75/15	11.20	21	M8/M10
F75/20	11.39	27	M8/M10
F75/25	11.77	34	M8/M10
F75/30	12.14	42	M8/M10
F75/40	12.90	48	M8/M10
F75/50	13.48	60	M8/M10
F75/60	19.36	76	M10
F75/80	22.40	89	M10
F75/100	25.43	114	M12
F75/125	26.57	140	M12
F75/150	30.55	166	M12
F75/200	35.77	219	M12

FINISH: PRE-GALVANIZED



"A" (mm)	UNIT PRICE C/W FASTENERS & STEEL BASE	CABLE OD
61	42 77.42	3 x Ø 30mm
74	43 84.76	3 x Ø 37mm
85	44 98.67	3 x Ø 43mm
93	45 105.00	3 x Ø 48mm
102	46 111.32	3 x Ø 53mm
122	47 113.85	3 x Ø 63mm

### F2246 - SERIES PIPE CLAMPS

PRODUCT RANGE	UNIT PRICE	PIPE DIAM. (mm)
F2246/20	32.64	60
F2246/25	36.06	76
F2246/30	40.23	89
F2246/40	69.07	114
F2246/50	78.18	140
F2246/60	87.29	166
F2246/70	125.24	191
F2246/80	133.97	216

FINISH: HOT-DIP GALVANIZED



















FASTENERS	QTY.	UNIT PRICE	TOTAL PRICE
M8 x20 HEX SET SCREW	2	2.16	4.31
M8 HEX NUT	2	0.89	1.78
M8 FLAT WASHER	4	0.32	1.28
<b>TOTAL SET</b>			<b>7.37</b>

# 5 CLAMPS, FASTENERS AND ANCHORS

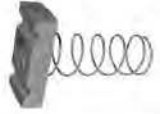
# STRUTFAST

## Fasteners and Anchors

FINISH ELECTRO-GALVANISED

DESCRIPTION		LENGTH	M6	M8	M10	M12	
			PRICE/EACH	PRICE/EACH	PRICE/EACH	PRICE/EACH	
HEX SET SCREW	20mm		0.59	1.14	2.02	2.90	
HEX SET SCREW	25mm		0.64	1.27	2.24	3.29	
HEX SET SCREW	30mm		0.76	1.42	2.48	3.61	
HEX SET SCREW	35mm		0.84	1.52	2.66	3.98	
HEX SET SCREW	40mm		0.89	1.84	2.92	4.24	
HEX SET SCREW	50mm		1.03	2.28	3.36	5.39	
HEX SET SCREW	60mm		1.58	2.45	3.84	5.63	
HEX NUT			0.22	0.48	1.03	1.52	
FLAT WASHER			0.11	0.15	0.32	0.43	
SPRING WASHER			0.13	0.19	0.39	0.51	
FENDER WASHER			0.89	1.23	1.79	1.70	
GUTTER BOLT & NUT	12mm		1.01	–	–	–	
GUTTER BOLT & NUT	16mm		1.14	–	–	–	
GUTTER BOLT & NUT	20mm		1.58	–	–	–	
CUP SQUARE BOLT, NUT & WASHER		16mm	0.89	2.53	–	–	
DOME HEAD SLOTTED SCREW, NUT & WASHER		20mm	–	–	3.17	–	
CONE POINT SCREW		45mm	–	–	7.22	8.23	
SQUARE NECK ROUND HEAD BOLT & NUT		16mm	–	4.43	–	–	
SPRING NUT (LONG & SHORT)			2.90	3.17	3.54	3.80	
SLEEVE ANCHOR	HOLE SIZE	60mm	–	–	–	–	
		65mm	–	–	–	–	
		70mm	–	–	–	–	
		75mm	–	–	–	–	
SHIELD ANCHOR			6.26	7.72	12.84	22.33	
NAIL - IN ANCHOR	40mm		1.01	–	–	–	
	55mm		1.11	–	–	–	
	80mm		–	2.78	–	–	
FLUORESCENT ADAPTER F2540 NYLON & NUT							
FLUORESCENT ADAPTER F2540 BRASS excl. NUT							
			5.18				
				49.34			